

Open the Statistics application.

Tap Edit, Clear All.

Enter the prime minister's ages below into **list1** by typing each number and tapping EXE and the president's ages into **list2**.

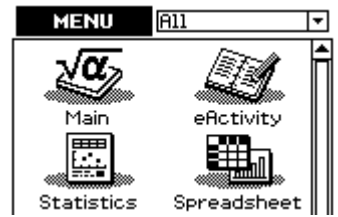

Here are the names of the last ten prime ministers of Australia together with the ages at which they took office and the last ten presidents of the USA together with the ages at which they took office.

Harold Holt	57	Dwight Eisenhower	62
John McEwen	67	John Kennedy	43
John Gorton	56	Lyndon Johnson	55
William McMahon	63	Richard Nixon	56
Gough Whitlam	56	Gerald Ford	61
Malcolm Fraser	45	Jimmy Carter	52
Bob Hawke	53	Ronald Reagan	69
Paul Keating	47	George H Bush	64
John Howard	56	Bill Clinton	46
Kevin Rudd	50	George W. Bush	54

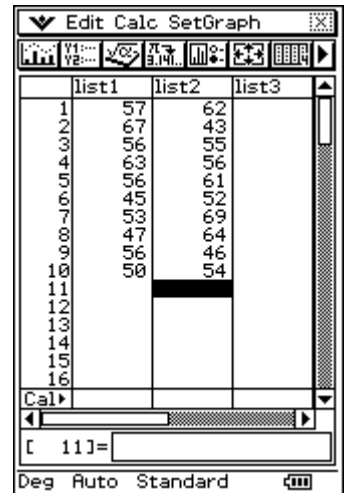

Tap  to open the Set StatGraphs window.

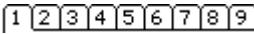
Notice the tabs  along the top of the window.

The window has 9 tabs and by default always opens to tab 1.

The radio button opposite Draw should be On.

On **tab 1** use the drop down menus to set

Type: MedBox
 XList: list1
 Freq: 1

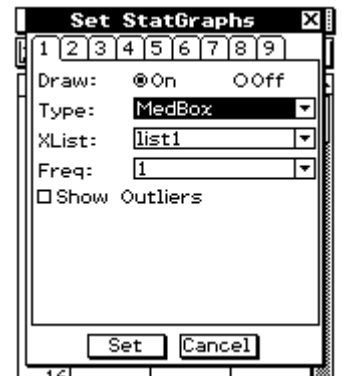

Tap on the 2nd tab.

Tap on the On radio button opposite Draw.

On **tab 2** use the drop down menus to set

Type: MedBox
 XList: list2
 Freq: 1

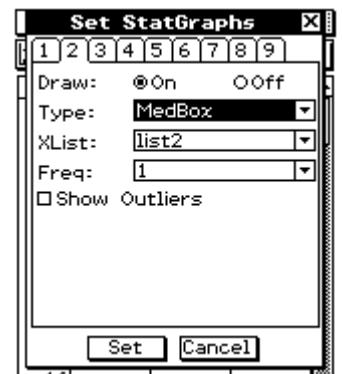

Tap **Set** to confirm your settings.

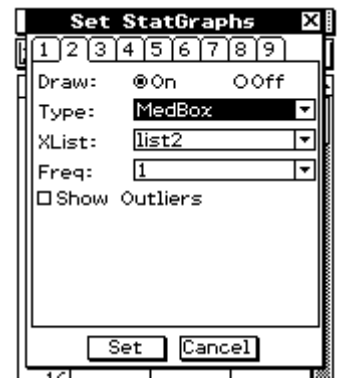

Tap the DrawGraph icon .

Tap **Resize** .

Tap  and observe the minX of the top boxplot is displayed at the bottom of the screen. Below minX, StatGraph1 is displayed, indicating the currently selected graph.

Use the cursor key to move left and right through the 5 key points of the top boxplot.

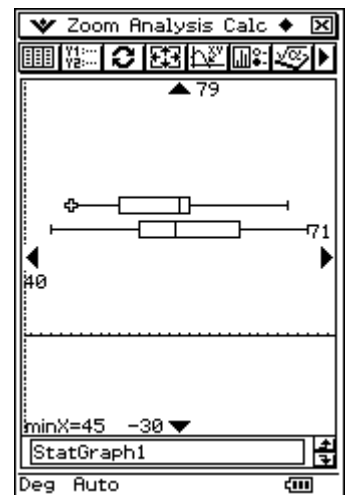

Use the cursor key to move up and down between StatGraph1 and StatGraph2.

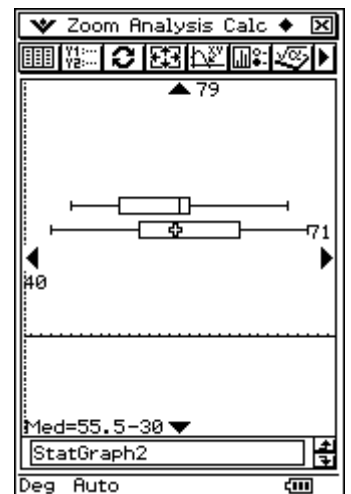

Tap close  in the top right hand corner of the screen.

	list1	list2	list3
1	57	62	
2	67	43	
3	56	55	
4	63	56	
5	56	61	
6	45	52	
7	53	69	
8	47	64	
9	56	46	
10	50	54	
11			
12			